

FATHOM

f112

f113

Owner's Manual



JL AUDIO[®]
Ahead of the Curve[™]

IMPORTANT SAFETY INSTRUCTIONS

WARNING: TO REDUCE THE RISK OF FIRE OR ELECTRIC SHOCK, DO NOT EXPOSE THIS PRODUCT TO RAIN OR MOISTURE.

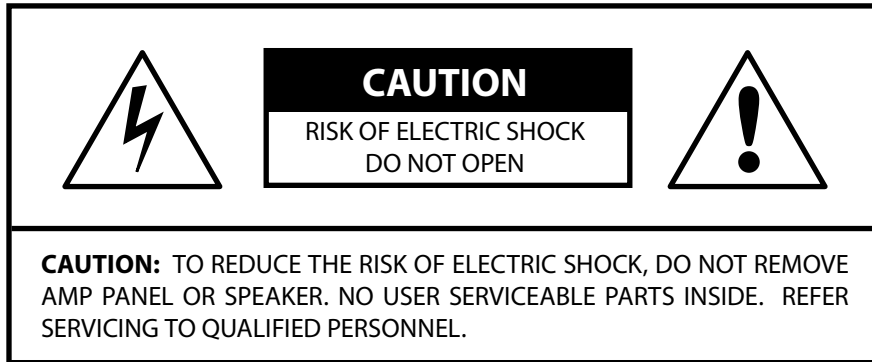

- 1) **Read the Instructions** — All safety and operating instructions should be read before the subwoofer is operated.
- 2) **Retain the Instructions** — The safety and operating instructions should be retained for future reference.
- 3) **Heed Warnings** — All warnings on the subwoofer and in the operating instructions should be followed.
- 4) **Follow Instructions** — All operating and use instructions should be followed.
- 5) **Water and Moisture** — The subwoofer should NOT be used near water – for example, near a bathtub, washbowl, sink, laundry tub, in a wet basement, near a swimming pool, etc.
- 6) **Ventilation** — The subwoofer should be situated so that its location or position does not interfere with its proper ventilation. For example, the subwoofer should not be situated on a bed, sofa, rug, or similar surface that may block airflow over the heatsink fins. If placing the subwoofer in a “built-in” installation, ensure that airflow to the heat sink at the rear of the subwoofer is not impeded. Do not cover the subwoofer heatsink with tablecloths, curtains, etc.
- 9) **Heat and Flames** — The subwoofer should be situated away from heat sources such as radiators, heat registers, stoves, fireplaces, or other devices which produce heat. Do not place candles on top of or near the subwoofer.
- 10) **Power sources** — The subwoofer should only be connected to a power supply of the type described in the operating instructions or as marked on the subwoofer.
- 11) **Power Cord Protection** — Power-supply cords should be routed so that they are not likely to be walked on or pinched by items placed upon or against them, paying particular attention to cords at plugs, convenience receptacles, and the point where they exit the subwoofer.



The lightning flash with arrowhead symbol, within an equilateral triangle, is intended to alert the user to the presence of uninsulated “dangerous voltage” within the product’s enclosure that may be of sufficient magnitude to constitute a risk of electric shock to persons.



The exclamation point within an equilateral triangle is intended to alert the user to the presence of important operating and maintenance instructions in the literature accompanying the product.

- 12) **Cleaning** — The subwoofer should be cleaned only as recommended in the operating instructions.
- 13) **Nonuse Periods** — The power cord of the subwoofer should be unplugged from the outlet when the subwoofer is left unused for long periods of time.
- 14) **Lightning and Power Surges** — We recommend that you disconnect the subwoofer from the electrical outlet during electrical storms and/or recurring power interruptions to prevent damage due to power surges.
- 15) **Object or Liquid Entry** — Care should be taken so that objects do not fall into and liquids are not spilled onto the subwoofer enclosure. Do not expose the subwoofer to dripping or splashing from liquids. Do not place objects filled with liquids on top of, or near the subwoofer. For example: flower vases, beverages, liquid-fueled lamps, etc.
- 16) **Damage Requiring Service** — The subwoofer should be serviced by qualified service personnel when:
- a. the power-supply cord or plug has been damaged
 - b. objects have fallen or liquid has been spilled into the subwoofer
 - c. the subwoofer has been exposed to rain
 - d. the subwoofer does not appear to operate normally or exhibits a marked change in performance
 - e. the subwoofer has been dropped or the cabinet has been damaged
 - f. the subwoofer driver's cone and/or suspension has been physically damaged
- 17) **Servicing** — The user should not attempt to service the subwoofer beyond what is described in the operating instructions. All other servicing should be referred to qualified service personnel.
- 18) **Overloading** — Do not overload wall outlets, extension cords, or outlet strips as this can result in a risk of fire or electric shock.
- 19) **Grounding** — This subwoofer is supplied with a three-prong, grounded power cord. Precautions should be taken so that the grounding means of the subwoofer are not defeated. Defeating the grounding prong on the subwoofer power cord could increase the risk of electric shock and could result in permanent damage to the subwoofer's electronics.

WARNING



THIS SUBWOOFER IS CAPABLE OF PRODUCING VERY HIGH SOUND PRESSURE LEVELS. PLEASE EXERCISE RESTRAINT IN ITS OPERATION TO PROTECT YOUR HEARING FROM PERMANENT DAMAGE.

TABLE OF CONTENTS

Important Safety Instructions:	2-3
Introduction:	4
Product Overview:	5
Placing your Fathom in Your Listening Room:	6-10
Unpacking your Fathom:	11
Front Control Panel Layout:	12
Rear Control and Connector Panel Layout:	13
Front Panel Controls in Detail:	14-17
Connecting your Fathom(s):	18-25
Recommended Setup Procedure:	26-30
Frequently Asked Questions:	31
Cleaning Your Fathom:	32
Troubleshooting:	33
Limited Warranty / Service Information:	35
Specifications:	36

INTRODUCTION

Congratulations on your purchase of a JL Audio *Fathom* powered subwoofer system. This product has been critically engineered to deliver exceptional performance in your home theater or audio system for many years to come.

As a company, we are intensely committed to core research into high-performance loudspeaker and amplifier technologies. JL Audio's long-excursion subwoofer driver designs are widely considered as reference standards for linear behavior and high output. We have also focused our efforts to create powerful amplifier and signal-processing technologies specifically aimed at delivering exceptional low-frequency performance. Your *Fathom* combines these core disciplines within a compact, beautifully crafted package to deliver an unparalleled listening experience.

We sincerely thank you for your purchase and invite you to read this manual thoroughly in order to achieve the highest level of performance with your *Fathom* subwoofer system.

Enjoy.

JL AUDIO TECHNOLOGIES INCLUDED IN *FATHOM* SUBWOOFERS

DMA-Optimized Motor System

DMA is JL Audio's proprietary Dynamic Motor Analysis system aimed at improving dynamic motor behavior. As a result of DMA optimization, loudspeaker motors remain linear in force over an extreme range of excursion and also maintain a highly stable fixed magnetic field over a wide power range. This leads to vastly reduced distortion and faithfully reproduced transients... or put simply: tight, clean, articulate bass.

OverRoll™ Surround

(U.S. Patent #5,687,247 and #5,949,898)

The OverRoll™ surround spans over the driver's mounting flange, utilizing available diameter wasted in conventional speakers. This allows the use of the wider roll necessary to control high-excursions without sacrificing precious cone area.

W-Cone™ (U.S. Patent #6,496,590)

The W-Cone™ is a unit-body cone assembly that delivers astonishing cone stiffness with minimal mass.

Floating-Cone™ Attach Method

(U.S. Patent #6,501,844)

This assembly technique ensures proper surround geometry in the assembled speaker for better excursion control and dynamic voice coil alignment.

Plateau-Reinforced Spider Attachment

(U.S. Patent #6,118,884)

This high-integrity suspension attachment relieves stress from the spider material at high-excursions for enhanced reliability.

Elevated Frame Cooling Technology

(U.S. Patent #6,219,431 and #6,229,902)

Delivers cool air, through slots directly above the top-plate, to the voice coil of the speaker. This enhances power handling and sound quality by minimizing dynamic parameter shifts and power compression.

Radially Cross-Drilled Pole Piece

(U.S. Patent #6,243,479)

This innovative venting system greatly enhances thermal dissipation and power handling by directing air flow onto the voice coil former, working in conjunction with the Elevated Frame technology.

High-Damping Feedback Circuit

(U.S. Patent #6,441,685)

This proprietary, discrete control circuit design allows our Class D switching amplifiers to maintain an excellent damping factor for improved transient behavior and fidelity.

PRODUCT OVERVIEW

JL Audio *Fathom* subwoofers combine a state-of-the-art JL Audio subwoofer driver and electronics/amplifier package within a highly optimized enclosure to deliver an exceptional listening experience in your home theater or home audio system.

The subwoofer driver in your *Fathom* subwoofer system is capable of exceptional linear excursion without distress or audible distortion. This exceptional driver enables your *Fathom* to reproduce powerful low-frequency events with stunning impact and unprecedented accuracy. Derived from JL Audio's legendary W7 design platform, the *Fathom* drivers offer peak-to-peak excursion capabilities well in excess of 3 inches (76mm) to comfortably handle the dynamics of the most demanding program material.

To get the most from this long excursion driver platform, prodigious amounts of controlled power are needed. Our electronics engineering team conducted an intense analysis of typical program material and its dynamic demands in order to balance current draw and actual output power requirements relative to the system's impedance characteristics. After careful study, a pair of precisely engineered switching amplifiers employing patented feedback technology were created. These advanced designs are capable of unclipped output voltages equivalent to 1500 watts (f112) and 2500 watts (f113) of RMS power when referenced to the nominal loudspeaker impedance, allowing us to take full advantage of each driver's full excursion envelope.

The beautiful cabinet enclosing the workings of your *Fathom* is also the result of careful engineering. To contain the pressures created by the *Fathom* driver, we utilized solid, CNC-cut, MDF material with extensive internal bracing features and advanced assembly techniques.

Your listening room is the other enclosure that affects the way your bass will sound. All rooms create a specific sonic signature, which must be effectively managed to achieve well-balanced low frequency performance. To aid in this process, the *Fathom* includes an extensive set of signal processing tools aimed at optimizing your *Fathom*'s performance within your listening space. These features include JL Audio's exclusive Automatic Room Optimization system.

As you can see from this brief introduction, there is a lot of technology in this compact subwoofer. The contents of this manual will explain the features, guide you through the setup and tuning of your *Fathom* subwoofer and help you achieve your ultimate low-frequency listening experience.

If you require assistance, we urge you to contact your authorized JL Audio retailer for expert setup advice and service.

IMPORTANT



IMPORTANT! IT IS A VERY GOOD IDEA TO READ THE NEXT SECTION BEFORE UNPACKING YOUR FATHOM. UNPACKING THE SUBWOOFER NEAR ITS FINAL LOCATION IS RECOMMENDED.

PLACING YOUR FATHOM IN YOUR LISTENING ROOM:

Your listening room or theater is an integral part of your sound reproduction system. The physical dimensions of the room and its furnishings, materials, doors and windows play an important role in defining how your system sounds.

When you place a sound source in an enclosed rectangular space, “standing waves” are created, resulting from the relationship between the sound’s wavelength and your room’s dimensions. In other words, standing waves result from sound energy that is trapped in the room as it bounces back and forth between opposing walls. Standing waves in the room create acoustic peaks and dips where the sound is either louder or softer, based solely on your physical position in the room. Energy also “builds up” at the room’s boundaries, creating exaggerated bass response at certain frequencies. These fundamental room resonances are called room “modes.”

The moral of this mode story is to try and avoid seating positions in standing wave peak or dip regions. It is highly recommended that you place your listening chairs in areas where modal peaks and dips are moderate and do not reinforce one another. The two most obvious areas to avoid are those near the exact center of the room and those close to any of the room’s walls.

Just as your listening seat can be in a peak or dip region, so can your subwoofer. When placed in a room corner, a subwoofer maximally excites the room’s mode structure, creating the strongest output with the fewest dips. When the subwoofer is pulled away from a corner or wall, the room modes are excited less, which can alter the sound at your listening seat.

Be sure to experiment with both your listening seat position and subwoofer position to find the best solution. Careful experimentation usually leads to a superior sounding system. Use our setup suggestions (illustrated on the opposing page and the following pages) to get you started.

If you cannot avoid placing your sofa against the back wall or your subwoofer in a less than optimal position, all is not lost. Your Fathom’s Automatic Room Optimization (A.R.O.) System can dramatically improve these less-than-ideal situations.

We recommend that you begin by placing your Fathom in the front of the room, near the front left or right speaker. Placing it directly in the front corner of the room will produce the maximum number of peaks and the minimum number of dips in the bass response. This can be advantageous because the Fathom’s A.R.O. system can correct the primary peak very effectively, whereas dips in response cannot be corrected via equalization. Dips in response can only be minimized via careful subwoofer and listener placement.

Placing the Fathom near solid walls will reinforce bass response and pulling it away from solid walls will decrease bass. Increasing the distance between the subwoofer and the walls may help to smooth upper bass response in some rooms.

We recommend that you avoid placing the Fathom near windows to prevent rattling and sound transmission to the outside world.



If you are planning to install your Fathom inside a cabinet, please refer to the guidelines on page 8.

Recommended Subwoofer Placement Options for One Fathom

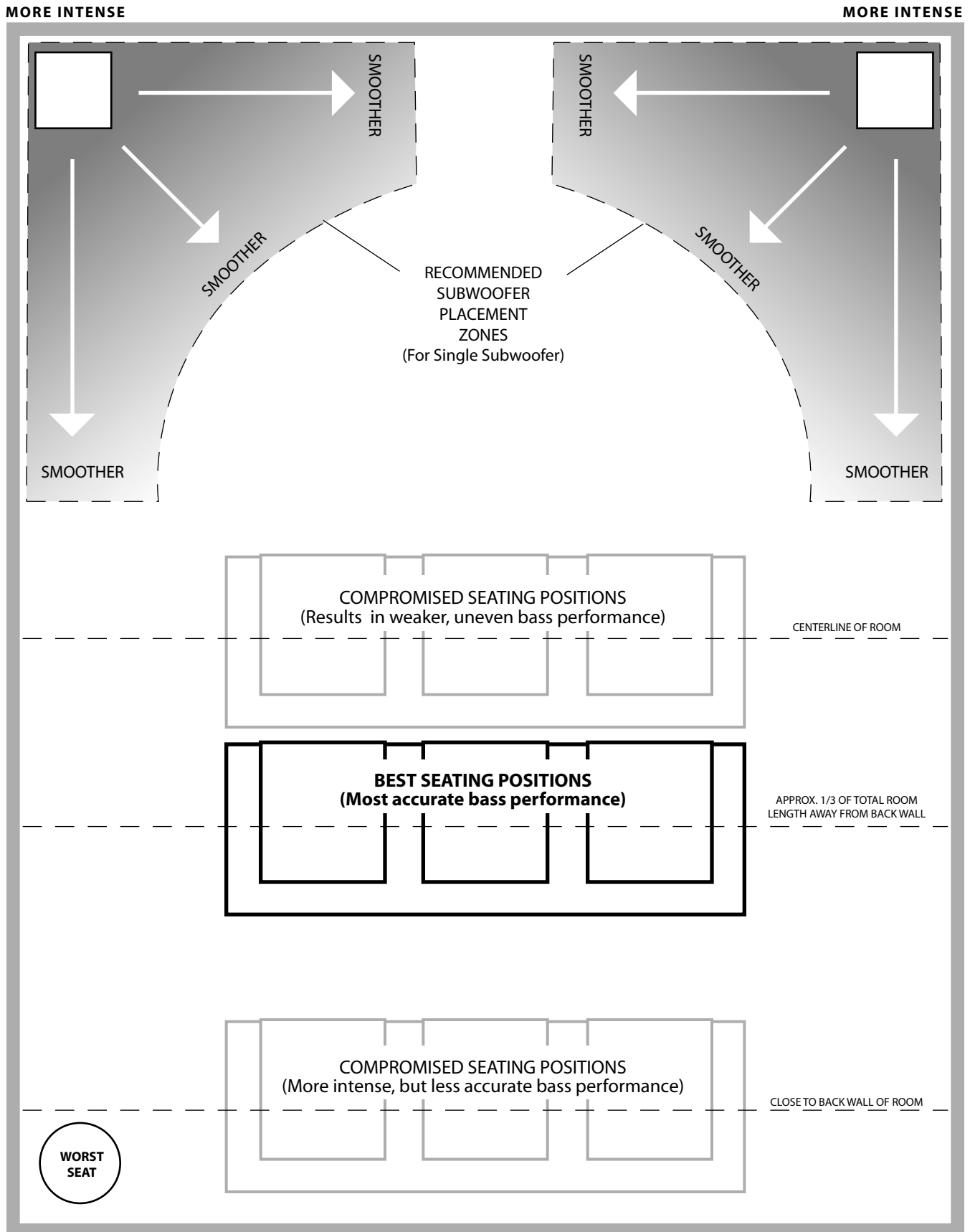

SPECIAL CONSIDERATIONS FOR BUILT-IN INSTALLATIONS

Fathom subwoofers are designed to be “built-in” friendly. All typically needed controls are located on the front panel above the woofer. A Fathom can be easily integrated into custom cabinetry by following a few simple guidelines.

- 1) Allow 4 inches (10 cm) of clear space behind the Fathom’s amp panel for adequate cooling and connector clearance.
- 2) On all other sides (except the bottom), allow at least 2 inches (5 cm) clearance for adequate ventilation.
- 3) While the Fathom generally runs only warm during spirited operation, we do recommend that adequate heat vents are included in any custom cabinet which encloses the Fathom. A pair of 3 inch (7.5 cm) diameter vents near the bottom of the cabinet and near the top of the cabinet, will allow cool air to circulate over the amp panel of your Fathom subwoofer system keeping it cool and happy.
- 4) Your Fathom subwoofer is capable of moving substantial quantities of air. If the front of the Fathom is covered by a custom grille, the grille must have AT LEAST 108 square inches (700 sq.cm.) of vent area for the f113 and AT LEAST 85 square inches (550 sq.cm.) for the f112. These areas are equal to the woofer cone area for each model and will ensure that the Fathom’s output is not choked by the custom cabinet.

Rear-view of cabinet install:

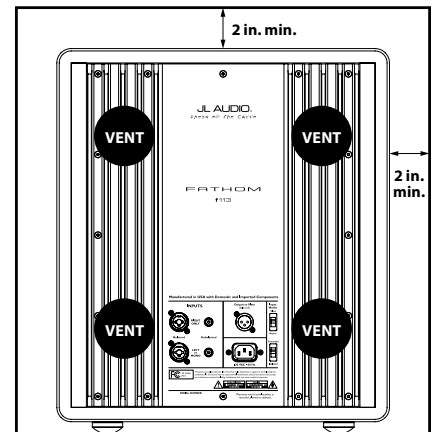

Using Two Fathoms

When using two Fathoms, try placement near the front corners of the room, at diagonally-opposite corners of the room, or at the center points of opposing walls as shown at right.

Experimentation with subwoofer and listener placement is recommended to achieve the best results – the benefits can be substantial.

High-resolution measurements and professional system calibration are recommended for the best possible results & system performance.

Recommended Subwoofer Placement Options for Two Fathoms

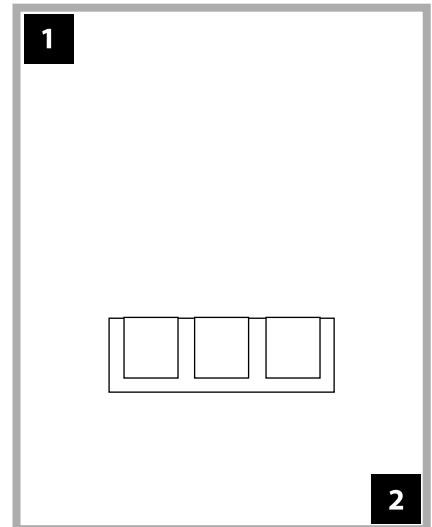
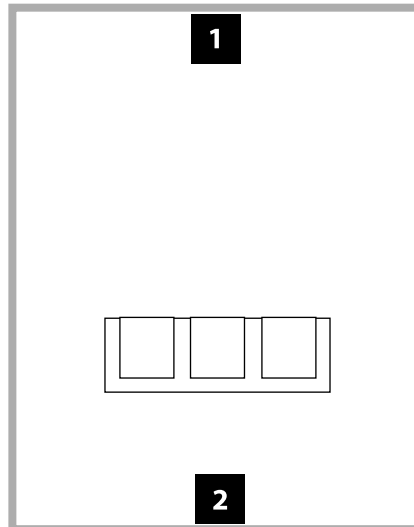
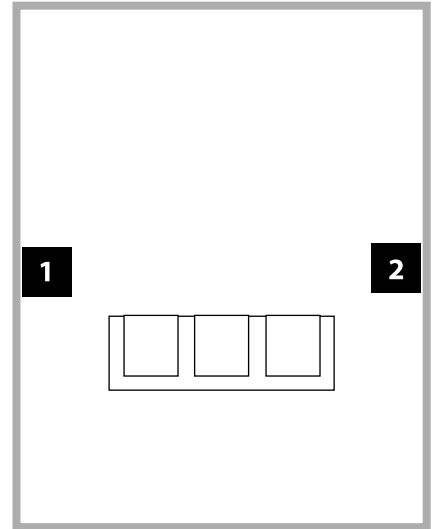
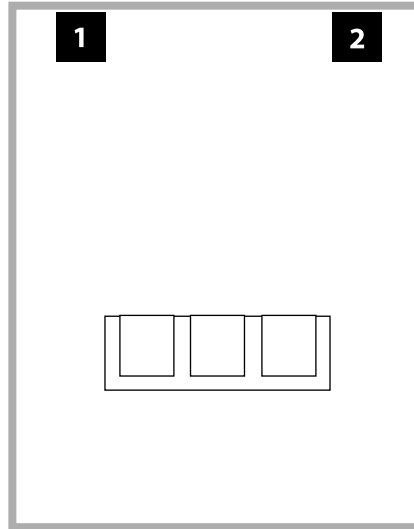

Recommended Subwoofer Placement Options for Three Fathoms

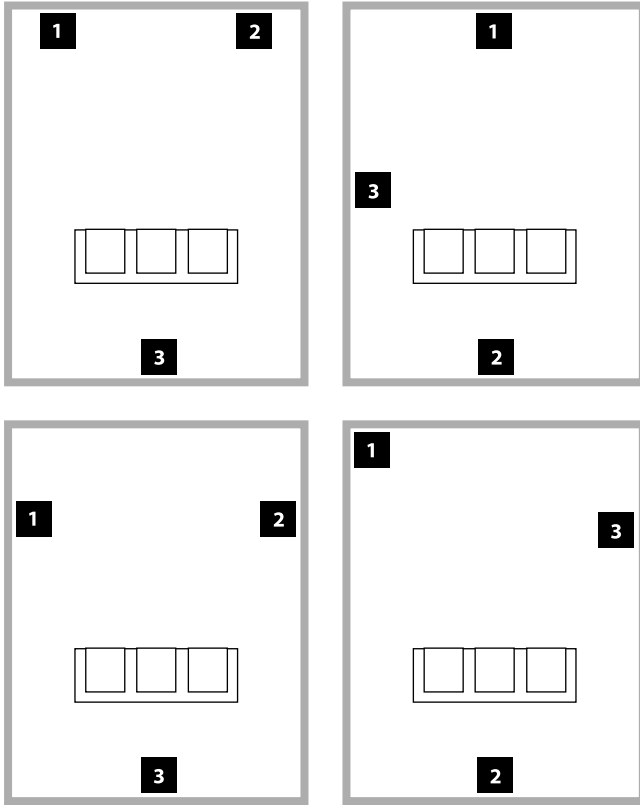

Recommended Subwoofer Placement Options for Four Fathoms

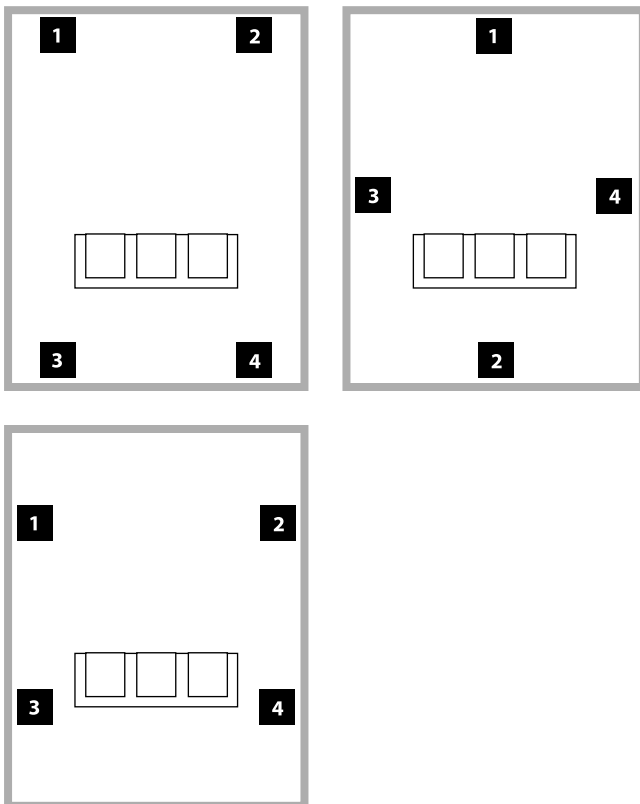

Using Three or Four Fathoms

Research indicates that the smoothest bass response for a large listening area can be achieved using four subwoofers, placing one at the midpoint of each of the four walls (although using two or three subwoofers can be almost as good).

Experimentation with subwoofer and listener placement is recommended to achieve the best results – the benefits can be substantial.

High-resolution measurements and professional system calibration are recommended for the best possible results & system performance.

Unpack this box close to where the subwoofer will be placed. The subwoofer is PACKED upside down. This box must be flipped over CAREFULLY to remove the subwoofer and minimize effort.

IMPORTANT



UNPACKING YOUR FATHOM

Now that you have determined your Fathom's position in the room, you can proceed with unpacking it near its intended location.

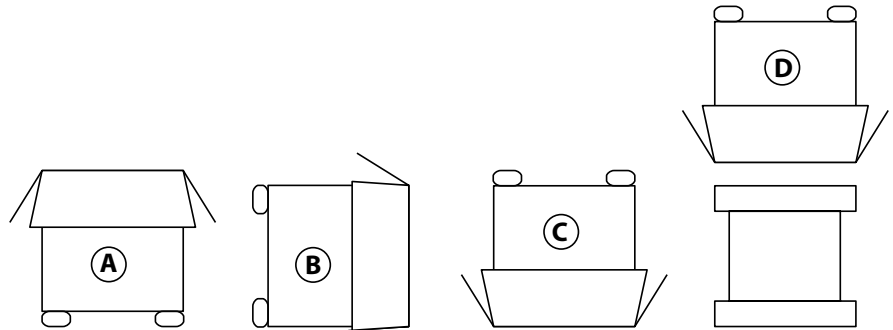

IMPORTANT: DUE TO THE WEIGHT OF THE FATHOM SUBWOOFER, PLEASE EXERCISE CAUTION WHILE UNPACKING AND POSITIONING IT TO PREVENT INJURY. IF POSSIBLE, ENLIST THE HELP OF A SECOND PERSON TO FACILITATE THE PROCESS. TO MINIMIZE THE RISK OF INJURY, BEND YOUR KNEES AND LIFT WITH YOUR LEGS, NOT YOUR BACK.

Detailed instructions on unpacking the subwoofer:

1. Place the carton on the floor near its intended location in the room.
2. Open the top of the carton (observe markings on carton) and remove the manual, calibration microphone and power cord.
3. Temporarily remove the split-foam packing inserts.
4. Untie and loosen the protective cloth cover to make later removal easier (do not remove at this time). When you open the cloth cover, you are looking at the bottom of the subwoofer cabinet.
5. Replace the split-foam inserts to protect the subwoofer's cabinet while unpacking.
6. Gently flip the box on its side, folding back the carton flaps to the outside.
7. Holding the carton flaps back, gently flip the carton onto its top (open end).
8. Pull the carton straight up until it clears the subwoofer and place to one side.
9. Remove the one-piece foam insert and place in the carton.
10. Remove the plastic bag and place in the carton.
11. Tilt the subwoofer forward (toward its grille) to remove the rear split-foam insert first. Then tilt the subwoofer in the opposite direction (towards its amplifier panel) to remove the remaining split-foam insert. Place both split-foam inserts in the carton.
12. Remove the protective cloth cover and place in the carton.

IMPORTANT



IMPORTANT! PLEASE RETAIN ALL PACKAGING FOR SAFE TRANSPORTATION OF THE SUBWOOFER AND FOR ANY FUTURE SERVICE

Front Control Panel

The labeled Figure below depicts the front control panel of a Fathom subwoofer. The f112 and f113 have identical layouts.

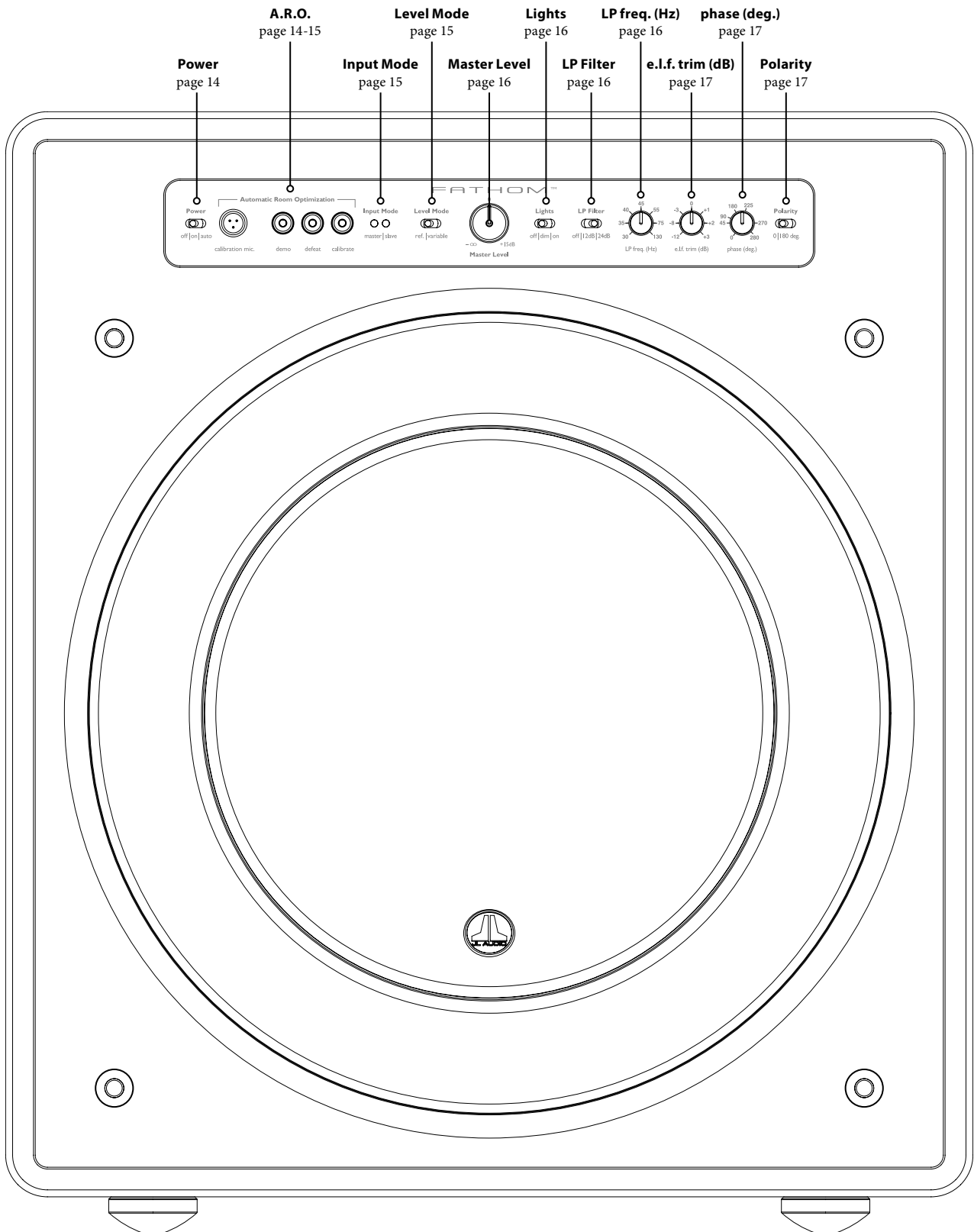

Rear Controls and Connectors

The labeled Figure below depicts the rear panel of a Fathom subwoofer. The f112 and f113 have identical layouts.

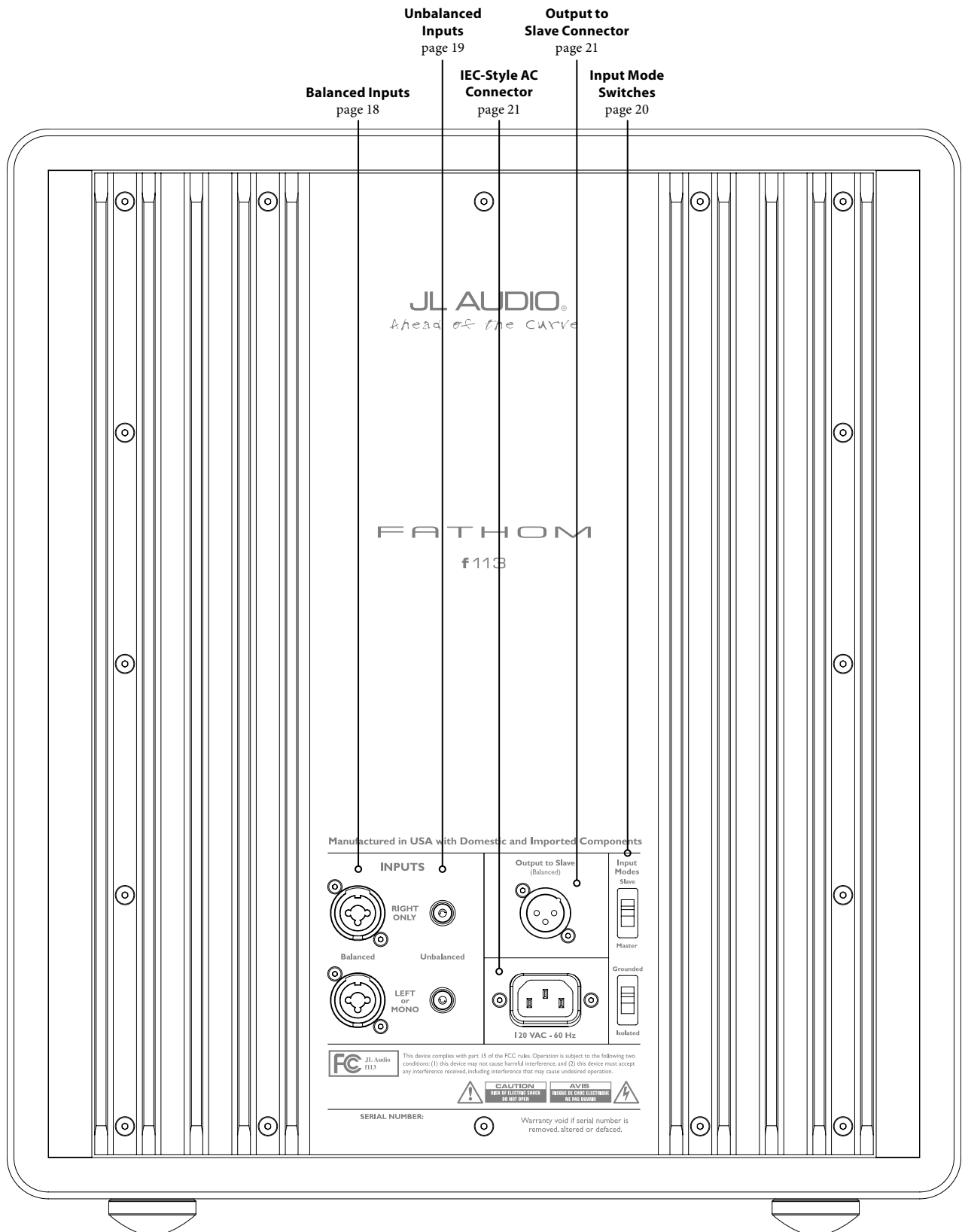

FRONT PANEL CONTROLS IN DETAIL

Power Switch

The “Power” switch determines the operational readiness of the Fathom subwoofer and should be the only switch used to turn the Fathom on and off. Do not use a power strip switch, switched outlet or any other external switch as these may result in undesirable and potentially damaging transient pops. Do not unplug the Fathom’s AC power cord while the unit is turned on.

The power switch has three positions:

“On”: The Fathom is fully powered at all times. Front panel lights are on unless they have been turned off via the “Lights” switch.

“Off”: The Fathom’s internal power amplifier is powered down. In this state, a negligible current draw will exist for operating the main power relays. All front panel lights are off.

“Auto”: The Fathom will power up its internal amplifier when an audio signal is present at any of its inputs and will power down the internal amplifier if no signal has been detected at its inputs for thirty (30) minutes. When dormant, the Fathom will draw a small amount of current to power its signal-sensing circuitry. Front panel lights will turn off when the Fathom powers down and light when the Fathom powers up (unless they have been turned off via the “Lights” switch).

Automatic Room Optimization (A.R.O.)

A powerful feature of the JL Audio Fathom subwoofers is their innovative Automatic Room Optimization (A.R.O.) technology. This one-touch system serves to eliminate the single largest acoustic response peak in your home theater at the main listening seat, greatly improving the in-room low-frequency response. Calibration of the A.R.O. system is fully automated and takes only a few minutes to accomplish. Please consult the next section of this manual for details on how to use the A.R.O. system

Using the included JL Audio calibration microphone, the A.R.O. calibration procedure takes less than three minutes. In brief, you will connect the included microphone to the “Calibration Mic.” input, press the Calibrate button, and then hold the microphone at ear height in your main listening seat during the test. A series of tones will be played through the Fathom subwoofer, and the room response will be automatically measured, analyzed and equalized to eliminate the single largest acoustic room response peak at your listening seat. **For detailed instructions on the A.R.O. setup procedure, refer to pages 29-30.**

Calibration Mic. Input

This input is for connecting the supplied JL Audio calibration microphone to the Fathom subwoofer. Connect one end of the supplied cable to the microphone and the other end to this jack prior to using the A.R.O. system. The A.R.O. system is specifically calibrated to this microphone and its connection scheme is specific to the supplied microphone. The calibration sequence will not operate when a different microphone is connected or if no microphone is connected.

Demo Button

The Demo button triggers a 20 second long tone sequence that briefly demonstrates the signals used during A.R.O. calibration. The Demo function is useful for showcasing the output capability of the Fathom and to verify that the Fathom (or multiple Fathoms) are operational during system troubleshooting.

To activate the demonstration sequence, press and hold the “Demo” button for approximately 2 seconds (this built in delay helps prevent accidental



IMPORTANT

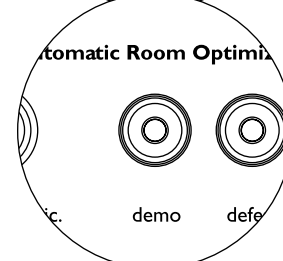
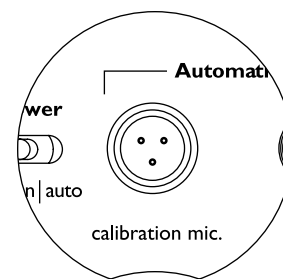
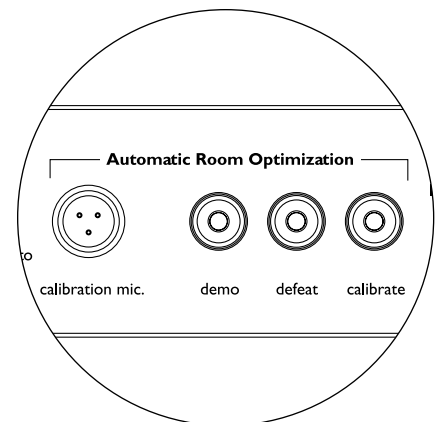
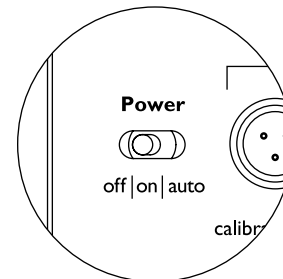

activation). Pressing and holding the “Demo” button will activate the demo sequence even if the A.R.O. defeat function is active (see below.) Once the demonstration sequence is complete, the Fathom will return to its previously set operating condition.

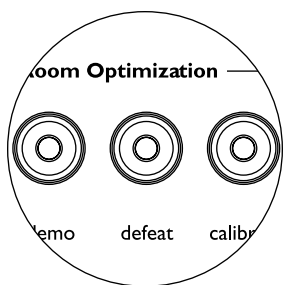

Defeat Button

The “Defeat” button turns off or “defeats” the A.R.O. calibration system and equalizer. Use this feature when you want to be sure that the A.R.O.’s equalization is not in the signal chain. You can also use the “Defeat” button to audition both the normal and the A.R.O. optimized settings in your home theater room. This is a great way to audibly verify what effect the A.R.O. has in your room.

If “Demo” or “Calibrate” is pressed while the defeat function is active, “Defeat” is automatically canceled. No other front panel controls will alter the A.R.O. Defeat state.

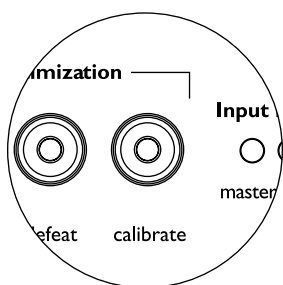

Calibrate Button

The Calibrate button activates the ARO test sequence. The calibration routine will not start unless the supplied JL Audio test microphone is plugged into the Fathom subwoofer. Once the calibration routine is complete, the green light in the center of the “Calibrate” button will light and remain illuminated. These settings are stored by the Fathom and will remain in memory even if power is disconnected.

During the ARO test sequence the Calibrate button’s green LED will alert the user to two special conditions:

1. “Subwoofer level too low for A.R.O. calibration” via slow blinking, approximately one blink per second
2. “Subwoofer level too high for A.R.O. calibration”, approximately three blinks per second.

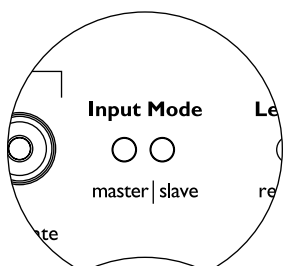

Input Mode Indicators

The Input Mode indicator LEDs show the input mode, either “Master” or “Slave”, selected by the switch on the Fathom’s back panel (unless the “Lights” switch is set to “off”). For further details, see page 20.

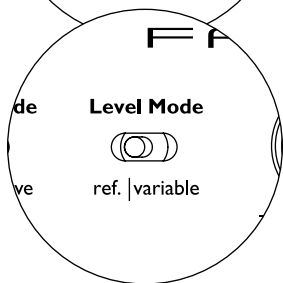

Level Mode

The two-position Level Mode switch allows you to select between the following modes:

“Reference”

In this mode, the Master Level control knob has no effect on the Fathom’s output level. Use this setting if you will primarily be controlling the subwoofer level via your receiver or preamplifier/processor. For those of us with small children or overenthusiastic teenagers, this mode of operation will prevent direct manipulation of the Master Level.

“Variable”

In this mode, the Master Level control knob determines the output level of the Fathom subwoofer. This mode is also useful when level matching the Fathom subwoofer to a pair of stereo speakers in a two-channel system. Variable level operation is needed for proper A.R.O. calibration.

Master Level Knob

The Master Level Knob is used to control the output level of the Fathom when the Variable Level mode is selected on the front control panel.

When rotated fully counter clockwise, the Fathom's output will be fully muted. When at the "0" or straight up position, the Variable gain level matches the Reference level setting. When turned fully clockwise, the Fathom's output level is 15 dB higher than the Reference setting.

Lights

The "Lights" selector switch allows the user to select one of three indicator light modes.

"Off" turns off all of the front panel LED's at all times.

"Dim" sets all of the front panel LEDs to a low brightness level when the Fathom is turned on.

"On" sets all of the front panel LEDs to full brightness level when the Fathom is turned on.

IMPORTANT: WHEN TROUBLESHOOTING OR CALIBRATING THE A.R.O. FEATURE, MAKE SURE THAT THE "LIGHTS" SWITCH IS SET TO "DIM" or "ON."

LP Filter

The Low Pass (LP) Filter selector switch determines the operating mode of the Fathom's built-in low pass filter.

"Off" defeats the low pass filter, completely removing this circuit from the signal path.

"12 dB" sets the roll off slope of the low pass filter to a 12 dB per octave slope (Butterworth alignment).

"24 dB" sets the roll off slope of the low pass filter to a 24 dB per octave slope (Linkwitz-Riley alignment).

The 24 dB setting more aggressively attenuates high frequencies above the LP Frequency setting (see below). If you are using the Fathom's built-in low pass filter, experiment with the LP Filter slope setting to achieve the best transition to your satellite speakers. If you prefer to use the filters and bass management features in your receiver or preamplifier, defeat the on-board filter by selecting the "Off" position.

LP Freq

The Low Pass (LP) Frequency selector knob allows the user to choose the roll-off frequency of the Fathom's internal low pass filter. The frequency is variable between 30 Hz (full counter-clockwise) to 130 Hz (full clockwise). This knob does not affect the input signal in any way if the LP Filter switch is set to "Off". 80 Hz is a commonly used filter frequency and usually serves as a good starting point for adjustments.

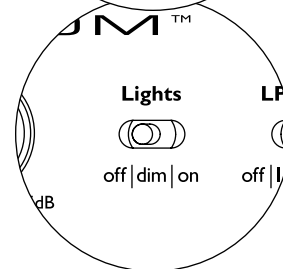
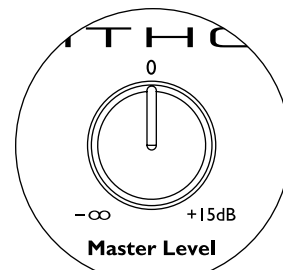

IMPORTANT

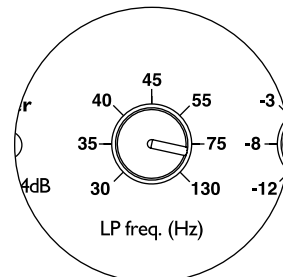
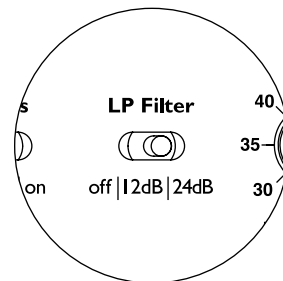

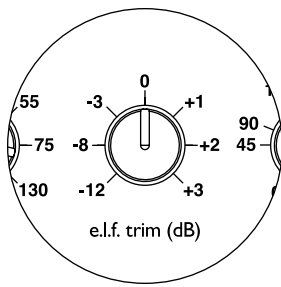

E.L.F. Trim

The Extreme Low Frequency (“e.l.f. trim”) knob allows the user to apply a certain amount of signal equalization at 25 Hertz (extremely low bass). At full counterclockwise rotation, the signal at 25 Hz is cut by 12 dB. At “0” the equalizer is set flat for zero contribution to the signal. At full clockwise rotation, the signal at 25 Hz is boosted by 3 dB.

The E.L.F. Trim feature is useful for tailoring the Fathom’s very low frequency output for your particular room. Adding some boost can make certain material more exciting. Using the cut function can help to compensate for room or boundary gain in the low frequencies. Room boundaries and the room’s finite (limited) size naturally cause very low frequencies to be boosted relative to other parts of the signal. As such, using the E.L.F. Trim feature to cut the lowest frequencies can help to tame “bloat” or unnatural sounding low bass in small to medium sized rooms (and can also reduce unwanted vibrations in the room or throughout the house).

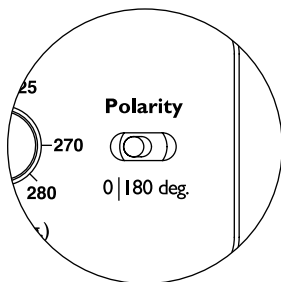

Polarity

The Polarity switch allows the user to select between normal (0 deg) and reversed (180 deg) signal polarity. The Polarity switch will primarily affect the small frequency range around the crossover point between your subwoofer and satellite speakers.

Unlike the Phase control, which effectively adds time delay, the Polarity switch produces an instantaneous reversal of the signal’s amplitude peaks. For example, if at a given reference point a sine wave has an amplitude peak, by flipping the phase switch you instantly convert that peak into a trough or amplitude dip. Because the effect of the Polarity switch is immediate, it compliments the operation of the Phase control and cannot be replaced by it.

When placing your Fathom in the room, experiment with the Polarity switch before adjusting the “Phase” control. Either position of the Polarity switch may provide a smoother transition between your Fathom subwoofer and the satellite speakers. Use source material with good mid and upper bass content for evaluation.

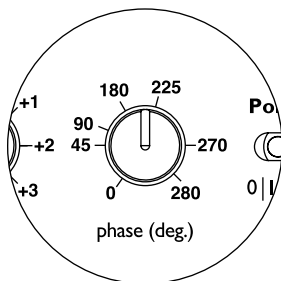

Phase

The Phase control knob allows the user to adjust the “timing” of the subwoofer output relative to the main speakers. The Phase control will primarily affect the small frequency range around the crossover point between your subwoofer and satellite speakers. The Phase control’s labels are referenced to 80 Hz since this is the most common crossover point between satellite speakers and a subwoofer. Phase settings between 0 degrees (full counter-clockwise rotation) and 280 degrees (full clockwise rotation) are possible.

Speaker, subwoofer, and listening seat positions vary greatly in home theater installations. Since physical positioning of speakers relative to the room boundaries and each other greatly affects the perceived quality of sound output, sometimes it is helpful to delay the subwoofer output. This is exactly what occurs when you turn the Phase control beyond 0 degrees.

Once your Fathom has been placed in your listening room to give you the smoothest overall sound and after you have determined the optimum “Polarity” switch position (see preceding section), experiment with the position of the Phase control. Using familiar source material with good mid and upper bass content, adjust the Phase control and listen for better defined mid-bass and a smoother transition between the subwoofer and satellite speaker systems. If no single setting sounds better than another, leave the Phase control at 0 degrees.

CONNECTING YOUR FATHOM

Balanced Inputs

If your home-theater receiver or preamplifier/processor provides balanced outputs, the Fathom's balanced inputs are the preferred connection. Balanced connections are used extensively in professional studios and sound reinforcement applications for a number of very good reasons. Besides ensuring proper grounding between components, balanced signal transmission is designed to cancel induced cable noise from the surrounding environment (particularly important with long cable runs). The bottom line is that your system will be far less likely to exhibit humming or other extraneous noises if you use balanced connections.

The Fathom subwoofers feature individual left and right balanced input connections with XLR "combo" jacks. These special jacks accept either a three-pin male XLR connector or a "tip-ring-sleeve" (TRS) 1/4-inch (6.3 mm) connector for compatibility with a wide range of equipment.

For systems with a mono subwoofer or "LFE" channel connection, only the jack labeled "Left or Mono" will be used. This applies to most modern multi-channel receivers and preamplifier/processors. Separate left and right input jacks are provided for systems without a dedicated mono subwoofer connection. This typically applies to two-channel audio equipment.

Appropriate balanced cables are available from your JL Audio dealer and are not included with the Fathom.

Technical Notes:

- Do not use the balanced inputs with unbalanced signals via adaptors. The unbalanced inputs of the Fathom are optically isolated and preferable in situations where only an unbalanced signal source is available.
- Input connectors are configured according to Audio Engineering Society recommendations for balanced signal cables as follows:

XLR Connection

- Pin 1: Shield
- Pin 2: Positive
- Pin 3: Negative

TRS connection:

- Tip: Positive
- Ring: Negative
- Sleeve: Shield

IMPORTANT: IF YOUR RECEIVER OR PREAMPLIFIER/PROCESSOR DOES NOT HAVE XLR OR 1/4-INCH TRS BALANCED OUTPUTS, PLEASE REFER TO THE "UNBALANCED INPUTS" SECTION ON PAGE 19 FOR INPUT CONNECTION INFORMATION. DO NOT ATTEMPT TO CONNECT UNBALANCED OUTPUTS TO THE FATHOM'S BALANCED INPUTS VIA ADAPTORS.

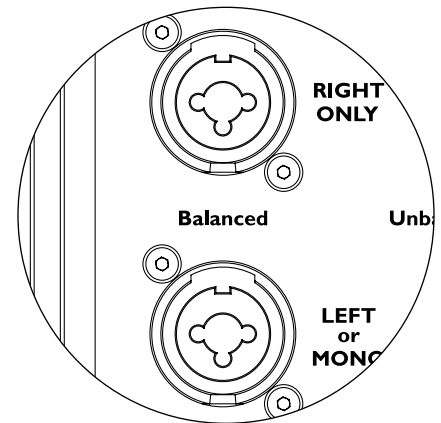

The Left and Right inputs on the Fathom are internally summed to a single mono channel. Since the Fathom is inherently a "mono" or single channel device, you can use the Left and Right inputs for the master Fathom and then distribute the summed mono signal to additional slave Fathoms in the system.



IMPORTANT

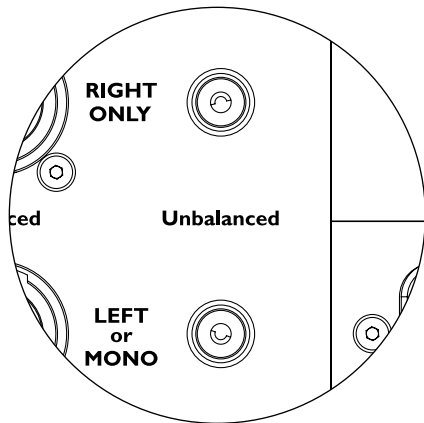

IMPORTANT



Unbalanced Inputs

The Fathom subwoofer features individual left and right unbalanced RCA-type input connectors. These are the most commonly used connectors for home audio applications and must be used if your receiver or preamplifier/processor does not provide balanced outputs. While unbalanced connections are not as noise-immune as a balanced connection, Fathom subwoofers employ optical isolation on the unbalanced inputs to minimize the possibility of noise in your system.

For systems with a mono subwoofer or “LFE” channel connection, only the RCA-type jack labeled “Left or Mono” will be used. This applies to most modern multi-channel receivers and preamplifier / processors. Separate left and right RCA-type input jacks are provided for systems without a dedicated mono subwoofer connection. This typically applies to two-channel audio equipment.

Technical Notes:

- When balanced outputs are not available on the signal source, you must use the RCA-type unbalanced inputs. Fathoms feature optical isolation circuitry on the unbalanced inputs to minimize the likelihood of ground loop induced noise.
- Connections are industry-standard for unbalanced signal cables as follows:
RCA-type connection:
 Tip: Positive
 Sleeve: Negative

IMPORTANT: IF NOISE EXISTS AFTER CONNECTION, FATHOMS ALLOW FOR GROUNDING OR ISOLATION OF THE UNBALANCED INPUTS. PLEASE REFER TO THE “INPUT MODE SWITCHES” SECTION ON PAGE 18 OF THIS MANUAL FOR FURTHER INFORMATION ON MINIMIZING NOISE.

Input Mode Switches:

Two switches are located on the rear panel to control unbalanced signal grounding and master/slave operation.

“Grounded / Isolated” Switch

The “Grounded / Isolated” Input Mode switch affects only the unbalanced RCA inputs and is designed to facilitate a quiet, hum-free connection to your audio or home theater system. This feature is included to deal with the signal grounding issues often encountered in home theater systems when several components from different manufacturers are interconnected.

The Fathom ships with this switch in the “Isolated” mode. If, with all system components connected and turned on (but no source material playing), you hear a continuous low-frequency hum through your Fathom, flip this switch to the “Grounded” position and evaluate the difference in the noise level. Use whichever switch position provides the least hum or noise.

IMPORTANT: PLEASE NOTE THAT CHANGING ANY COMPONENT IN THE OPTIMIZED SYSTEM (RECEIVER, AMPLIFIER, DVD PLAYER, ETC.) COULD ALTER THE SIGNAL GROUNDING SCHEME AND CAUSE HUM TO APPEAR IN YOUR PREVIOUSLY QUIET SYSTEM. IF YOU ADD OR CHANGE AN UPSTREAM COMPONENT IN YOUR HOME THEATER SYSTEM, YOU MAY NEED TO REVISIT THIS INPUT MODE SETTING ON THE FATHOM SUBWOOFER FOR OPTIMUM NOISE PERFORMANCE.

Master / Slave Switch

The Fathoms are designed to easily accommodate the implementation of multiple subwoofers in your home theater system through a master/slave connection chain. This method allows you to utilize the signal processing features of one Fathom to centrally control multiple Fathoms in the room. Master/Slave functionality also makes it possible for the A.R.O. system to optimize the response of a multiple subwoofer installation.

The Fathom ships with this switch in the “Master” position. If you are using a single Fathom you will use the “Master” position and you need not concern yourself with this section any further.

If your installation incorporates two or more Fathoms, you will designate one Fathom as the “Master” and all others in the system as “Slave” subwoofers via the “Master/Slave” switch on the rear amplifier panel of each Fathom. LED’s on the front panel of the Fathom are provided to indicate whether the “Master” or “Slave” mode is selected for a given subwoofer.

From the Fathom operating in “Master” mode, the “Output to Slave” signal carries any signal processing selected on the Master Fathom (including the Master Level setting and A.R.O. processing) to further Fathoms operating in “Slave” mode. “Slave” subwoofer signal processing and level controls will be inoperable. In this mode, the user does not have to worry about level, crossover, and other settings for the slave subwoofers.

Technical Notes:

- Selecting the “Slave” position defeats all user-definable signal processing and the master level control. Because of this, there are some special situations in which you may want to operate a single Fathom in “Slave” mode. If you are utilizing outboard signal processing and level-matching controls, activating the “Slave” mode will prevent anyone from affecting system parameters with the manual controls on the Fathom.

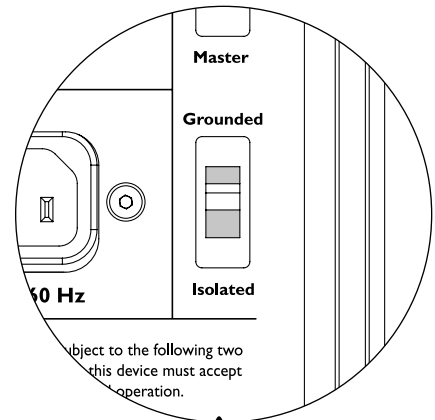

IMPORTANT

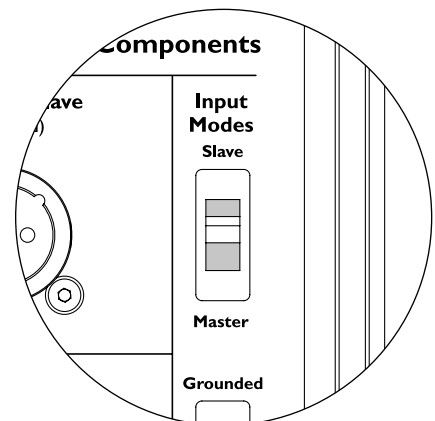

IMPORTANT



IMPORTANT: PLEASE REFER TO THE “SYSTEM CONNECTION DIAGRAMS” ON PAGES 26-29 FOR MORE INFORMATION ON USING THE INPUT / OUTPUT CONNECTIONS.

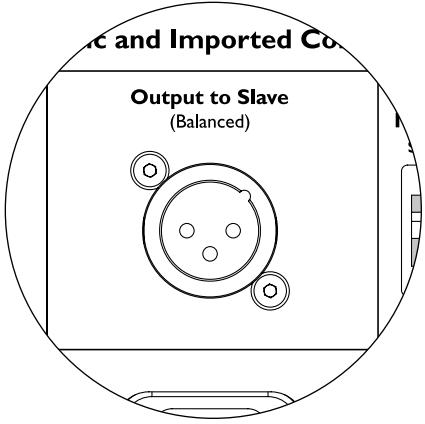

“Output to Slave” Connector

If you are operating more than one Fathom subwoofer in one home theater system, you will designate one Fathom as the Master (see page 20), and then feed signal from it to the remaining “Slave” Fathoms via this balanced XLR output. The “Output to Slave” cable can be connected to the “Left or Mono” balanced XLR input on the next Fathom. When a Fathom is in “Slave” Mode, its “Output to Slave” connection can be used to pass signal to further Fathoms operating in “Slave” mode.

The “Output to Slave” connector is designed to be used as follows:

- 1) From the “Master” Fathom’s “Output to Slave” connector to the first “Slave” Fathom’s “Left or Mono” XLR balanced input.
- 2) From the first “Slave” Fathom’s “Output to Slave” connector to the second “Slave” Fathom’s “Left or Mono” XLR balanced input.
- 3) From the second “Slave” Fathom’s “Output to Slave” connector to the third “Slave” Fathom’s “Left or Mono” XLR balanced input. Etc, etc. (up to ten Fathoms may be connected in this configuration). Appropriate balanced cables with XLR terminations are available from your JL Audio dealer and are not included with the Fathom.

Technical Notes:

- The “Output to Slave” signal carries any signal processing selected on the Master Fathom (including the Master Level setting and A.R.O. processing) to further Fathoms operating in “Slave” mode.
- From Fathoms operating in “Slave” mode, the “Output to Slave” signal is an exact, buffered replica of the balanced input signal, making this method of signal distribution preferable to using Y-adapters or splitters.
- Use only shielded, connection cables with high quality XLR connectors for Master/Slave connection. Never use unbalanced cables with adapters.

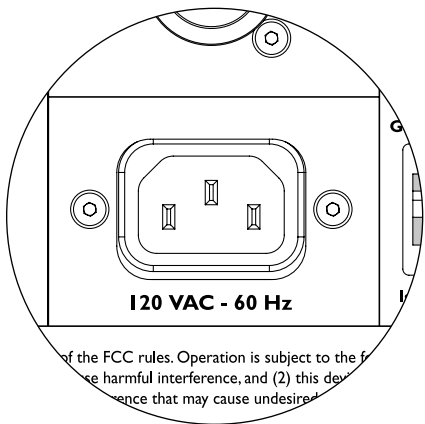

IEC-Style AC Connector

The IEC-style AC cord receptacle receives the heavy-gauge, 6 ft. (1.8 m) long, power cord included with your Fathom subwoofer. Your Fathom should only be powered from a 120 V AC, 60 Hz outlet. Do not use any AC power cord other than the one supplied with the Fathom.

The Fathom subwoofer is a very powerful device and can draw a lot of current. If too many components are connected with a Fathom subwoofer to one electrical outlet, you risk tripping a household circuit breaker during very demanding program material. If this happens, split the Fathom and other components between two AC electrical circuits. If possible, for maximum performance, dedicate an AC circuit to each Fathom.

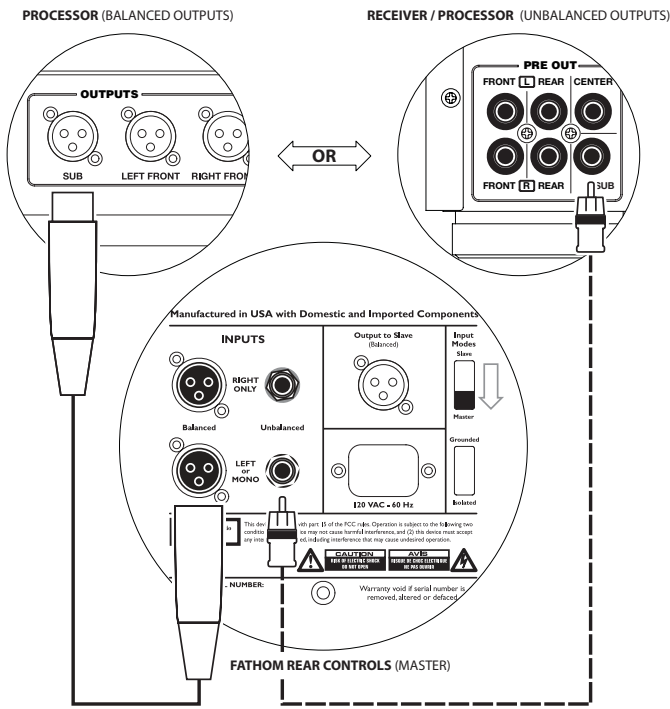

**SYSTEM CONNECTION DIAGRAM 1:
One Fathom to
Home Theater Receiver or
Home Theater Preamp/Processor**

Most home theater receivers and preamp/processors provide a single (mono) subwoofer output. When connecting a mono subwoofer output to your Fathom, you will only use the Fathom's "Left or Mono" input.

Two connection types are available for connecting the Fathom to your home theater system: balanced (XLR or 1/4-inch TRS connector) and unbalanced (RCA-type connector). Balanced connections provide superior noise rejection and ensure proper grounding between components. If your receiver or processor has balanced outputs, we highly recommend that you use them.

In the connection diagram at left, balanced connections are shown as solid lines, unbalanced connections are shown dotted. You will only use one of these input connection methods (not both).

WARNING! TURN OFF THE FATHOM AND ALL OTHER EQUIPMENT IN THE SYSTEM BEFORE MAKING OR CHANGING ANY CONNECTIONS!



**SYSTEM CONNECTION DIAGRAM 2:
Multiple Fathoms to
Home Theater Receiver or
Home Theater Preamp/Processor**

To greatly simplify using multiple subwoofers in a single home theater system, Fathoms incorporate a “Master/Slave” signal distribution system. This allows control of all the Fathoms in a system from a single “Master” unit.

First, you will select one of the Fathom subwoofers as the “Master” via its upper “Input Mode” switch. Generally, you will designate the Fathom closest to the receiver/preamp as the master. In some cases; for example, when the control panel of certain units is difficult to access, you may prefer to designate the one which is easiest to access as the master.

Two connection types are available for connecting the master Fathom to your home theater system: balanced (XLR or 1/4-inch TRS connector) and unbalanced (RCA-type connector). Balanced connections provide superior noise rejection and ensure proper grounding between components. If your receiver or processor has balanced outputs, we highly recommend that you use them to connect to the Fathom designated as the master.

In the connection diagram at left, balanced connections are shown as solid lines, unbalanced connections are shown dotted. You will only use one of these input connection methods for the Fathom designated as the master (not both).

The remaining Fathoms in the system will be configured as “Slave” units via their upper “Input Mode” switches. Using balanced XLR cables, you will connect the master Fathom’s “Output to Slave” to the “Left or Mono” balanced input of the first slave Fathom. That slave unit’s “Output to Slave” connector will feed the “Left or Mono” input of the next slave unit via another balanced XLR cable. Subsequent slave units will be connected in the same manner.



IMPORTANT

Connections between the “Master” and “Slave” Fathoms and between “Slave” Fathoms are via balanced XLR cables ONLY.

WARNING



WARNING! TURN OFF THE FATHOM(S) AND ALL OTHER EQUIPMENT IN THE SYSTEM BEFORE MAKING OR CHANGING ANY CONNECTIONS!

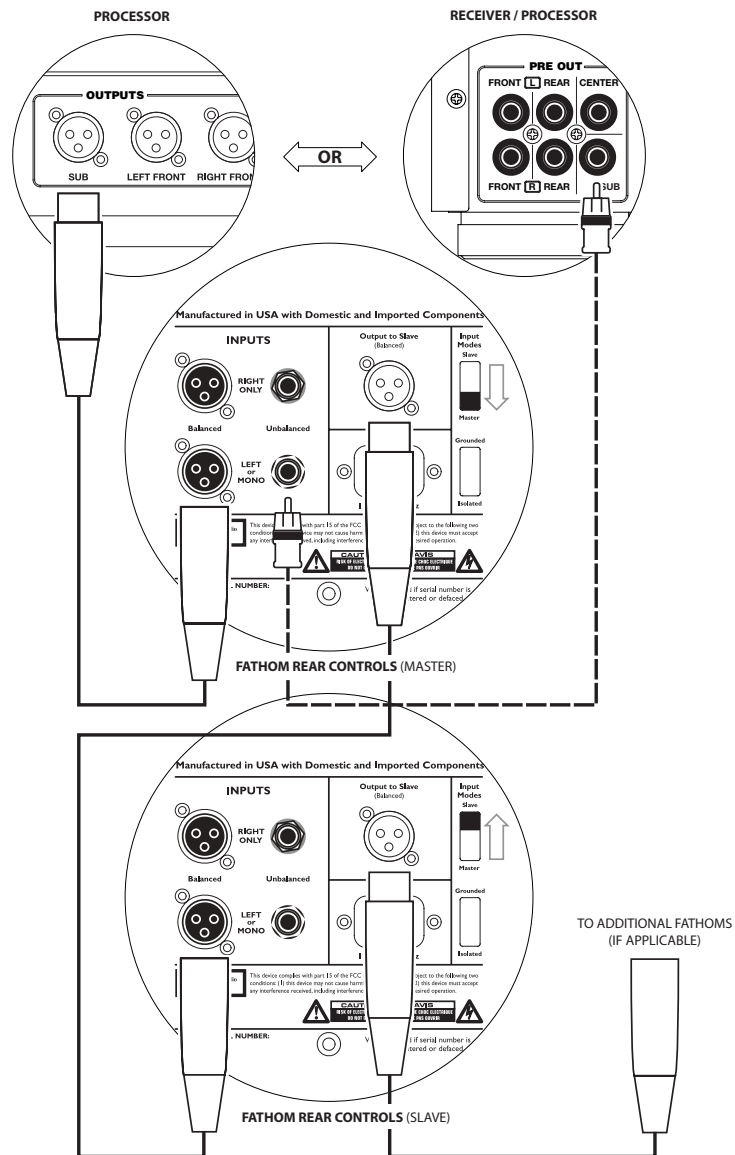

STEREO ACTIVE CROSSOVER (BALANCED OUTPUTS)

STEREO ACTIVE CROSSOVER (UNBALANCED OUTPUTS)

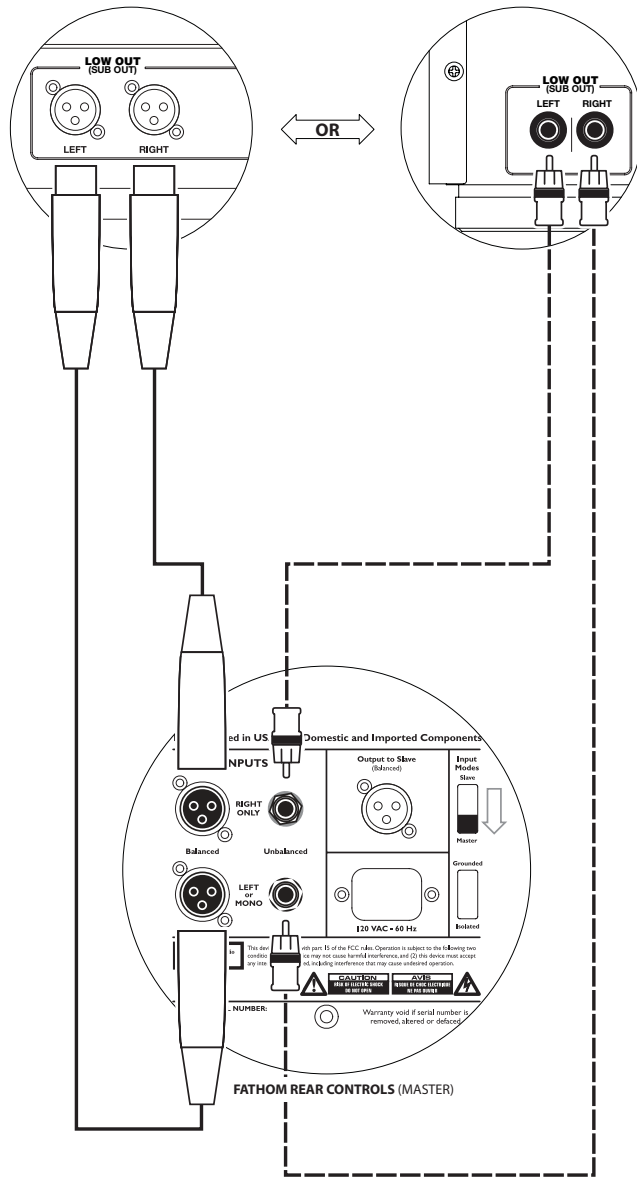

SYSTEM CONNECTION DIAGRAM 3: One Fathom in Mono to Two-Channel Audio System

When connecting a Fathom (or multiple Fathoms) in mono to a two-channel audio system you will use both the “Left or Mono” and the “Right” inputs. Summing circuitry in the Fathom’s input section will sum the stereo signals to mono.

We strongly recommend that you use a high-quality active crossover to divide your preamplifier’s signals prior to connection to the Fathom and to the amplifier driving your main speakers. This will allow you to filter low frequencies out of the signals driving the main speakers, resulting in better performance.

If you are not using an active crossover and are comfortable running your main speakers full-range, you can split your preamplifier’s output signals using appropriate Y-connectors in place of the active crossover shown in the diagram.

Two connection types are available for connecting the Fathom to your two-channel audio system: balanced (XLR or 1/4-inch TRS connector) and unbalanced (RCA-type connector). Balanced connections provide superior noise rejection and ensure proper grounding between components. If your preamplifier or active crossover offers balanced outputs, we highly recommend that you use them.

In the connection diagram at left, balanced connections are shown as solid lines, unbalanced connections are shown dotted. You will only use one of these input connection methods (not both).

NOTE: If desired, additional Fathoms can be connected in “Slave” mode to the Fathom connected as shown on this diagram. See “Connection Diagram 2” on page 23 for slave connection explanation.

WARNING! TURN OFF THE FATHOM AND ALL OTHER EQUIPMENT IN THE SYSTEM BEFORE MAKING OR CHANGING ANY CONNECTIONS!



WARNING

**SYSTEM CONNECTION DIAGRAM 4:
Two Fathoms in Stereo to
Two-Channel Audio System**

When connecting two Fathoms in stereo to a two-channel audio system you will only use the “Left or Mono” inputs of each Fathom. The upper “Input Mode” switch on each Fathom will be set in the “Master” position.

We strongly recommend that you use a high-quality active crossover to divide your preamplifier’s signals prior to connection to the Fathom and to the amplifier driving your main speakers. This will allow you to filter low frequencies out of the signals driving the main speakers, resulting in better performance.

If you are not using an active crossover and are comfortable running your main speakers full-range, you can split your preamplifier’s output signals using appropriate Y-connectors in place of the active crossover shown in the diagram.

Two connection types are available for connecting the Fathoms to your two-channel audio system: balanced (XLR or 1/4-inch TRS connector) and unbalanced (RCA-type connector). Balanced connections provide superior noise rejection and ensure proper grounding between components. If your preamplifier or active crossover offers balanced outputs, we highly recommend that you use them.

In the connection diagram at right, balanced connections are shown as solid lines, unbalanced connections are shown dotted. You will only use one of these input connection methods (not both).

NOTE: If desired, additional Fathoms can be connected in “Slave” mode to each Fathom connected as shown on this diagram. See “Connection Diagram 2” on page 23 for slave connection explanation.

STEREO ACTIVE CROSSOVER (BALANCED OUTPUTS)

STEREO ACTIVE CROSSOVER (UNBALANCED OUTPUTS)

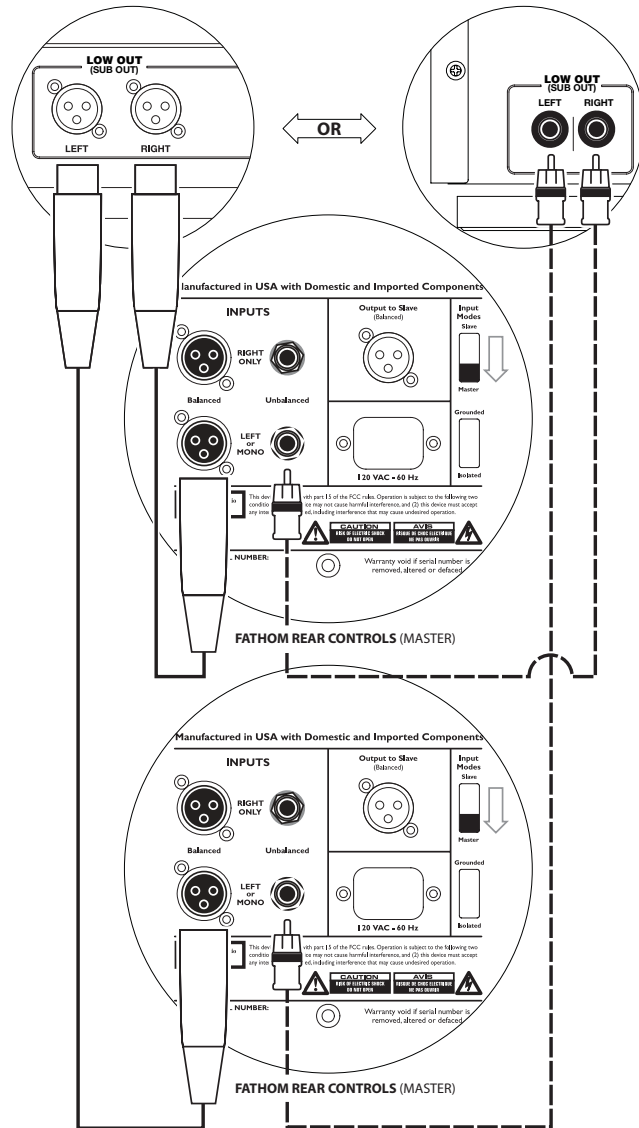

WARNING

WARNING! TURN OFF THE FATHOM(S) AND ALL OTHER EQUIPMENT IN THE SYSTEM BEFORE MAKING OR CHANGING ANY CONNECTIONS!

RECOMMENDED SETUP PROCEDURES

1) Preparation for Setup Process:	26-27
2) Level Setting:	28
3) Polarity/Phase Adjustment:	28
4) Experiment with Location:	28
5) Apply A.R.O:	29-30
6) Adjust E.L.F. Trim:	30

PREPARATION FOR SETUP PROCESS:

Please confirm the following system settings before beginning the setup process. This will ensure a neutral starting point and an effective setup of your subwoofer system.

On your Home Theater Receiver or Preamp/Processor:

Before beginning setup of your Fathom subwoofer system we recommend that you set your receiver or preamp/processor as follows (please turn off all Fathoms in the system prior to making these adjustments):

1. Speaker Size

In the speaker setup menu of your receiver or preamp/processor, set up all of your high-frequency speakers as “small” with a crossover point of 80 Hz. This will send ALL bass to the Fathom(s).

2. Speaker Distance

In the speaker setup menu, properly set all speaker distances to the primary listening seat, including the subwoofer’s distance. Use a tape measure to determine these distances (time coherence is important.) If multiple Fathoms are being used, average their distances to the primary listening seat and use that number to set the subwoofer distance.

3. Subwoofer Level

Set the subwoofer level in the receiver or preamp/processor “0” or its middle position.

4. Tone Controls / Equalizers

Set all tone controls to “0” and defeat all equalizer features.

On your Active Crossover or Bass Management Processor:

If you are using an active crossover or bass-management processor, we recommend that you set it as follows before beginning setup of your Fathom subwoofer system (please turn off all Fathoms in the system prior to making these adjustments):

1. Low-Pass Filter Frequency

Select a low-pass filter frequency of 80 Hz (12dB/octave slope)

2. High-Pass Filter Frequency

Select a high-pass filter frequency of 80 Hz (12dB/octave slope)

3. Low-Pass (Subwoofer) Output Level

Set the subwoofer output level to “0” or its middle position.

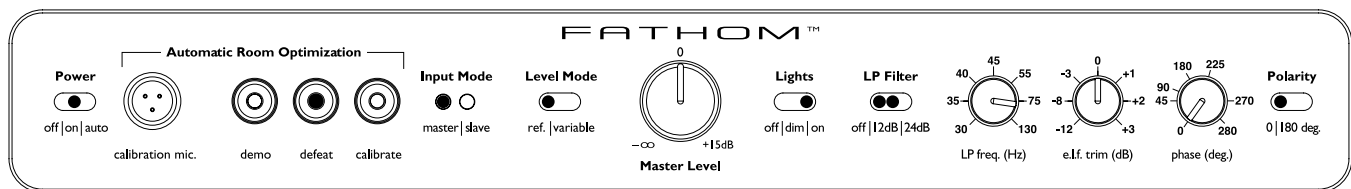

On the Fathom's Front Panel:

Please turn off the home theater receiver or preamp/processor to make these adjustments.

1. "Power" Switch

Flip each Fathom's "Power" switch to the "On" position.

2. "Lights" Switch

Flip each Fathom's "Lights" switch to the "On" position. If you don't see any lights on the front panel, you may have forgotten to plug the Fathom in or there may be a problem with the electrical circuit.

3. "Input Mode" Indicator Lights

If you are using a single Fathom, confirm that its "Input Mode" indicator light is on the "Master" position. If not, you will need to access the upper "Input Mode" switch on the rear panel of the Fathom.

If you are using multiple Fathoms in a Master/Slave configuration, confirm that the unit connected directly to your receiver or preamp/processor is indicating "Master" on its "Input Mode" lights and that all other units are indicating "Slave" on their "Input Mode" lights. If not, you will need to access the upper "Input Mode" switches on the rear panels of the Fathoms.

3. "Level Mode" Switch

Flip the master Fathom's "Level Mode" switch to the "REF" position.

4. "LP Filter" Switch

If your home theater receiver/processor is handling bass management (speakers set on "small") or if you are using an outboard crossover/bass-management processor, flip the master Fathom's "LP Filter" switch to "OFF." If not, select the "12 dB" position.

5. "LP Freq. (Hz)" Knob

Rotate the "LP Freq." knob to the "80 Hz" position.

6. "e.l.f. trim (dB)" Knob

Rotate the "e.l.f. trim" knob to "0"

7. "Polarity" Switch

Flip the "Polarity" switch to "0".

8. "phase (deg.)" Knob

Rotate the "phase" knob to "0" degrees

9. A.R.O. Defeat Switch

Press the A.R.O. defeat switch so that the red light in the switch remains lit.

RECOMMENDED SETUP PROCEDURES *(continued)*

Subwoofer System Setup:

Once you have set the controls on your home theater receiver or preamp/processor and on your Fathom(s) to the settings recommended on pages 26 and 27, you are ready to begin setting up your Fathom for optimum performance.

1) Level Setting

Using familiar music or movie material with deep bass content, adjust the subwoofer level to blend with the other speakers using your receiver or preamp/processor's subwoofer level control. This method is more immune to tampering than using the Fathom's "Master Level" knob (think toddlers or curious visitors).

In the unlikely event that the subwoofer level control in your receiver or preamp/processor cannot be turned up enough to level match the Fathom, return that control to "0". Then, flip the Fathom's "Level Mode" switch to "Variable" and with "0" as your reference point (REF mode gain and Variable "0" gain are identical) use the "Master Level" control to level match the subwoofer with the other speakers. **MAKE NOTE OF THIS SETTING FOR FUTURE USE.**

For more detailed information on your Fathom's level setting controls, please refer to the "Level Mode" and "Master Level" sections on page 29 of this manual.

2) Polarity and Phase Adjustment

It is often helpful to have a second person operating these controls so that you can easily hear the changes from the primary listening seat.

Listening to familiar source material (preferably music with good upper bass and midbass response), flip the "Polarity" switch from "0" to "180" and listen for differences. The correct setting will sound most natural with the best upper bass punch and articulation. If both sound similar, choose "0".

Once Polarity is set, use the same music material to audition different "Phase" control settings and choose the one that further enhances the upper and midbass response. If you can't hear a difference, set the control to "0."

3) Experiment with alternative subwoofer locations (if necessary).

If you are satisfied with the basic performance of your subwoofer you are ready to move on to the next step. If not, we recommend that you experiment with the position of your subwoofer until you are pleased with its basic performance. Experimenting with placement is KEY to a superior sounding system. Moving the subwoofer just a few feet can have a significant effect on the smoothness of the bass. For each new position, start with the polarity and phase controls at "0" and repeat the setup process beginning with Step 1.

IMPORTANT! WRITE DOWN ALL SETTINGS PERFORMED IN STEPS 1-3 FOR FUTURE REFERENCE.



IMPORTANT

IMPORTANT



IMPORTANT! IMPORTANT! MAKE SURE THE ROOM IS QUIET DURING A.R.O. CALIBRATION! TURN OFF ANY NOISY APPLIANCES NEAR THE LISTENING ROOM (DISHWASHERS, WASHING MACHINES, ETC.)

IT IS PARTICULARLY IMPORTANT TO TURN OFF AIR CONDITIONERS OR HEAT PUMPS DURING CALIBRATION. THESE FORCED-AIR-TYPE HVAC SYSTEMS CAN CREATE MODERATE LEVELS OF 15 – 20 HZ NOISE THAT MAY INTERFERE WITH CALIBRATION.

DO NOT TALK, COUGH OR SNEEZE DURING CALIBRATION AS THIS MAY CORRUPT THE CALIBRATION MEASUREMENTS.

4) Applying Automatic Room Optimization (A.R.O.)

You are now ready to apply the power of JL Audio's exclusive Automatic Room Optimization system. This system will measure the response of the subwoofer at your primary listening seat and apply a powerful equalizer to tame the primary room mode, resulting in smoother, more accurate bass performance. If you are using multiple Fathoms in a master/slave configuration, you will only need to address the unit designated as "master" to perform A.R.O. calibration for the entire subwoofer system.

- a) Set the Main Power switch to the "ON" position and be sure the Fathom's indicator lights are switched "ON" via the "Lights" switch.
- b) Flip the Fathom's "Level Mode" switch to "Variable" and turn the Master Level control to the "12 o'clock" position. If you were already in "Variable" mode, make a note of the volume position you established during Level Setting (Step 1) before turning it to the "12 o'clock" position for A.R.O. calibration. In most cases, you will need to tweak the overall level of the subwoofer after the A.R.O. calibration is run, but you need to know your prior setting to begin that process.
- c) Set the LP Filter to "OFF"
- d) Verify that the "e.l.f. trim" control is set to "0"
- e) Remove the calibration microphone from its protective pouch and connect its cable to the mini-XLR jack on the Fathom's front control panel.

NOTE: A.R.O. Calibration is only possible when the included JL Audio test microphone is plugged in to the Fathom front panel. The "Calibrate" feature is disabled with no microphone plugged in to prevent accidental loss of settings.

- f) Connect the microphone to the other end of the mic cable and temporarily place the mic in the primary listening seat. If you have a microphone stand, you can place the microphone at head height and position in the primary listening seat.
- g) On the Fathom's control panel, press the "Calibrate" button. The green light on the "Calibrate" button will turn on, indicating that calibration will begin in 5 seconds.

NOTE: If you have already run A.R.O. once, the "Calibrate" light will already be on. Each time A.R.O. calibration is run, the previous settings are erased and the new settings are stored.

- h) Within 5 seconds of pressing the “Calibrate” button, return to your primary listening seat and hold the microphone in your normal, seated head position at the approximate height of your ears.
- i) A series of quick, stepped tones will begin which are used by the A.R.O. software to set an appropriate bass level at your seat for the test. If these tones stop after two to five cycles, the “Calibrate” button’s light will start to blink, indicating a level setting error.
Slow blinking (approximately once per second) indicates the level selected on the “Master Level” control was too low. Increase the Master Level control approximately one eighth of a turn and go back to Step “g”.
If the Calibrate light is blinking quickly (approximately 3 times per second), this indicates that the “Master Level” was set too loud. Decrease the Master Level control by approximately one eighth of a turn and return to Step “g”.
- j) When the “Master Level” is properly set, a slow series of tones will be played from 20 Hz to 100 Hz after the stepped, level-setting tones. During this process, the A.R.O. system is taking a frequency response measurement at your listening seat. When A.R.O. is finished calibrating, the “Calibrate” button will light and stay on, indicating a successful calibration.
- k) Return your Fathom’s front panel controls to their previously determined settings (before the A.R.O. calibration run) and re-tweak the subwoofer output level as described in Step 1 (Level Setting) on page 28. Since the A.R.O. will smooth the largest peak in the bass response at the listening seat, the apparent subwoofer level may appear lower. Simply increase the subwoofer level until you are satisfied.

IMPORTANT! IF YOU MOVE YOUR FATHOM OR PRIMARY LISTENING SEAT IN THE FUTURE, YOU WILL NEED TO RUN A.R.O. AGAIN. ANY PARTICULAR CALIBRATION IS UNIQUE TO THAT PARTICULAR SUBWOOFER POSITION AND LISTENING SEAT POSITION COMBINATION. SIMPLY FOLLOW THE STEPS ABOVE TO CREATE A NEW CALIBRATION CURVE.



IMPORTANT

5) Extreme Low Frequency (e.l.f.) Trim

Use the “e.l.f. trim” control to adjust the extreme low bass extension of the Fathom. This control allows -12 dB of cut or +3 dB of boost at 25 Hertz and is particularly useful when using a Fathom (or two) in a small to medium sized home theater. Since smaller enclosed spaces help to boost the level of the lowest bass frequencies, smaller theaters can be overwhelmed by the strong low-bass output of the Fathom subwoofer. This can create a “thick” or “bloated” character in the lower bass region. Turning down the “e.l.f. trim” knob cuts the extreme low bass level and alleviates this condition. Feel free to experiment and listen to a variety of demanding material until you find the best match for your room and your tastes.

Your Fathom is now optimized for maximum bass performance at your listening seat. Congratulations!

FREQUENTLY ASKED QUESTIONS

Can I place objects on my subwoofer?

We do not recommend placing any items on the subwoofer cabinet as they may vibrate, causing undesirable noise and possible damage to the finish. Under no circumstances should any object containing liquid be placed on the Fathom cabinet.

Is the Fathom magnetically shielded?

Fathom subwoofers are not magnetically shielded. To avoid magnetic distortion with certain television types, place the Fathom at least 3-4 feet (1 - 1.5m) from your screen. If you notice any discoloration in the picture, try moving the subwoofer further away until these artifacts disappear.

Will my electric bill be high if I leave the Fathom in “Auto” mode?

When in “Auto” mode, the Fathom amplifier is only powered up when a significant signal is detected on the inputs. When powered down, only “housekeeping” circuits remain on, which draw negligible amounts of power from the wall (less than 5 watts).

Should I unplug my subwoofer during a thunderstorm or extended absence?

YES. You should unplug your Fathom during (or before) thunderstorms. This will prevent any possible damage from voltage spikes due to lightning. In these conditions, it's a good idea to unplug all of your audio / video components. If you are going to be away from home for several days, it is also a good idea to unplug your home theater components to prevent damage from unexpected storms or power line conditions.

CLEANING YOUR FATHOM

Dust your Fathom subwoofer's cabinet using a clean, soft microfiber cloth or feather duster. Microfiber cloths are commonly available where automotive detailing supplies are sold.

Gloss-black models:

Light smudges can generally be wiped off with a clean microfiber cloth. For more stubborn smudges, polish and protect the finish using a high-quality automotive wax and a microfiber cloth, both available wherever automotive detailing supplies are sold. We recommend Meguiar's® "NXT Tech Wax" and Meguiar's® Microfiber Detailing cloths.

Never use a polish that contains harsh solvents or abrasives as these may permanently damage the finish. Never use furniture polish or any oil-based product on your Fathom. Never use solvents or aggressive cleaning agents on your Fathom. When in doubt, test the cleaning product on the underside of the cabinet and let it sit for several days before committing to its use on visible portions of the cabinet.

TROUBLESHOOTING

No sound from subwoofer.

1. Verify that Fathom is plugged in, turned “ON” & that front panel lights are “ON”. If the Fathom will not power up, check the circuit breaker that feeds its outlet.
2. Test subwoofer using DEMO button on front panel – if sub emits demo tones the subwoofer’s internal circuitry is fine and an input problem is likely. Check the input cable connections at the Fathom and at the receiver/preamp/processor.
3. Verify that your receiver’s subwoofer settings have not changed
4. If your other speakers play, but the Fathom does not, try changing the cable that connects the Fathom to the system.
5. If the problem persists, call your dealer or JL Audio Technical Support for assistance.

The bass level has changed.

1. Make sure your level settings (on the Fathom and in your receiver/preamp/processor) have not changed.
2. If you are using the Fathom’s “Master Level” knob to set the subwoofer level, confirm that the “Level Mode” switch is set to “Variable”.
3. Verify the position of the ELF Trim knob.

Hums or other unusual noises from your Fathom

1. See Input Mode discussion on page 20 of this manual, especially if any upstream components, cables, etc., have recently changed.
2. Turn off the Fathom, disconnect all its input and output signal cables, turn the Fathom back on. If the noise disappears, the noise is being caused elsewhere in your system.

Bass sounds “muddy” or “too heavy”.

1. Try decreasing the 25 Hertz level using the “e.l.f. trim” control. Muddy bass can sometimes be caused by too much low frequency output in a moderately sized room.
2. Decrease the overall subwoofer level.
3. Verify your receiver’s subwoofer settings.
4. Try a different subwoofer or main listening seat location. Changing one or the other can have a HUGE effect on how your system sounds. See the placement discussion on pages 6-10 of this manual.

Your Fathom is clearly audible outside of your house.

1. Revisit the “Master Level” setting on your Fathom(s) or your home theater receiver/preamp/processor.
2. Inquire with your JL Audio dealer about noise isolation strategies.
3. Move the Fathom away from windows.

Angry neighbors knocking at your door.

Invite them in and offer them a beverage.

LIMITED WARRANTY / SERVICE INFORMATION

JL AUDIO warrants this product to be free of defects in materials and workmanship for a period of three (3) years from the original date of purchase.

Damage caused by the following is not covered under warranty: accident, misuse, abuse, product modification or neglect, failure to follow installation instructions, unauthorized repair attempts, misrepresentations by the seller. This warranty does not cover incidental or consequential damages and does not cover the cost of removing or reinstalling the unit(s) or shipping the unit(s) to JL Audio for service. Cosmetic damage due to accident or normal wear and tear is not covered under warranty.

This warranty is not transferable and applies only to the original purchaser of the product from an authorized JL AUDIO dealer. Warranty is voided if the factory-applied product serial number is removed or defaced.

Should service be necessary under this warranty for any reason due to manufacturing defect or malfunction, JL AUDIO will, at its discretion, repair or replace the defective product with new or remanufactured product at no charge.

Any applicable implied warranties are limited in duration to the period of the express warranty as provided herein beginning with the date of the original purchase at retail, and no warranties, whether express or implied, shall apply to this product thereafter. Some states do not allow limitations on implied warranties, therefore these exclusions may not apply to you. This warranty gives you specific legal rights, and you may also have other rights which vary from state to state.

If you need service on your JL AUDIO product:

All warranty returns should be sent to JL AUDIO freight prepaid through an authorized JL AUDIO dealer and must be accompanied by proof of purchase (a copy of the original sales receipt.) Direct returns from consumers or non-authorized dealers will be refused unless specifically authorized by JL AUDIO with a valid return authorization number. Warranty expiration on products returned without proof of purchase will be determined from the manufacturing date code. Coverage may be invalidated as this date is previous to purchase date. Return only defective components. Non-defective items received will be returned freight-collect. Customer is responsible for shipping charges and insurance in sending the product to JL AUDIO. Freight damage on returns is not covered under warranty. Always include proof of purchase (sales receipt).

For Service Information in the U.S.A. please call:

JL Audio customer service:

(954) 443-1100 during normal business hours (Eastern Time)

JL Audio, Inc • 10369 North Commerce Parkway, Miramar, FL 33025

International Warranties:

Products purchased outside the United States of America are covered only by that country's distributor and not by JL Audio, Inc.

FATHOM

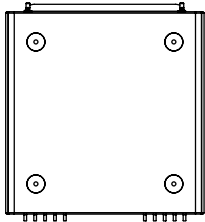

BOTTOM

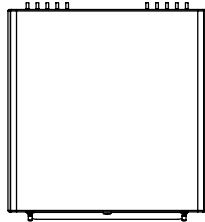

TOP

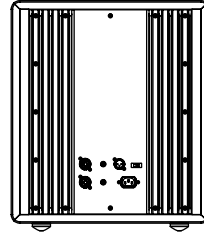

BACK

FRONT

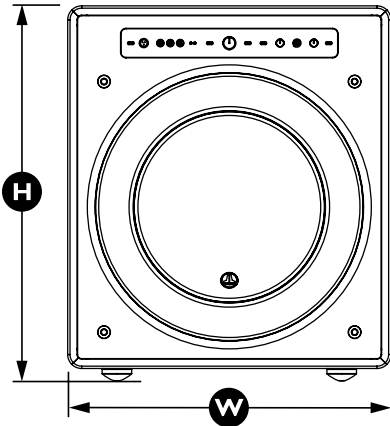

SIDE WITH GRILLE

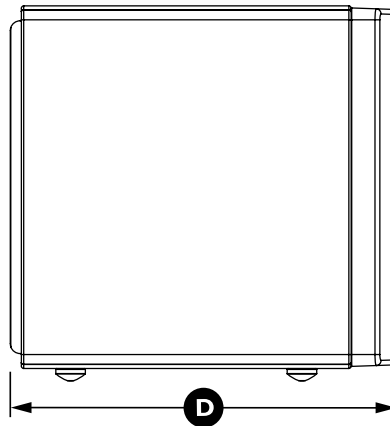

Specifications	f112 fathom home subwoofer	f113 fathom home subwoofer
Enclosure Type:	Sealed	Sealed
Driver:	Single 12-inch (nominal diameter)	Single 13.5-inch (nominal diameter)
Frequency Response:	20-200 Hz (+1dB / -3dB)	19-200 Hz (+1dB / -3dB)
Effective Piston Area:	84 sq. in. (0.0542 sq. m)	107.35 sq. in. (0.0693 sq. m)
Effective Displacement:	287 cu. in. (4.7 liters)	386 cu. in. (6.3 liters)
Amplifier Power:	1500 watts RMS short-term	2500 watts RMS short-term
Dimensions: (H) Height x (W) Width x (D) Depth Height Dimensions include feet.	18.5 in. x 15.0625 in. x 17.75 in. 470 mm x 384 mm x 451 mm	19.75 in. x 16.5 in. x 19.25 in. 502 mm x 419 mm x 489 mm
Net Weight:	115 lbs. (52 kg)	130 lbs. (59 kg)
Cabinet Finishes:	High-Gloss Black or Satin Black	High-Gloss Black or Satin Black

JL AUDIO®

Ahead of the Curve™

(954) 443-1100

www.jlaudio.com

"JL Audio®", and the JL Audio logo are registered trademarks of JL Audio, Inc. "Ahead of the Curve" is a trademark of JL Audio, Inc. Due to continuous product development, all specifications are subject to change without notice.

JLA-SKU011172-01-2007rev1 • Printed in USA • ©2006 JL Audio, Inc. • U.S. PATENTS: #5,734,734 #5,949,898 #6,118,884 #6,229,902 #6,243,479 #6,294,959 #6,501,844 #6,496,590 #6,441,685 #5,687,247 #6,219,431 #6,625,292 #D472,891 #D480,709 Other U.S. & Foreign patents pending. For more detailed information please visit us online at www.jlaudio.com.



10369 NORTH COMMERCE PARKWAY • MIRAMAR, FLORIDA • 33025 • USA

FEATURES

Unbalanced Inputs:

Stereo or Mono (RCA jacks)

Balanced Inputs:

Stereo or Mono (female XLR combo jacks)

Output To Slave:

Balanced (male XLR jack)

Input Modes:

Master or Slave

Level Modes:

Reference (fixed gain) or Variable from full mute to +15dB over reference gain

Power Modes:

Off, On or Automatic Signal-Sensing

Light Modes:

Off, On or Dim

Low Pass Filter Mode:

Off, 12 dB per octave or 24 dB per octave

Low Pass Filter Cutoff Frequency:

Variable from 30 Hz – 160 Hz

Polarity:

0 or 180 degrees

Phase:

Variable from 0 – 280 degrees

E.L.F. Trim:

Variable from -10 dB to +5 dB at 20 Hz

Automatic Room Optimization (A.R.O.)

with included calibration microphone, defeatable.